

# INSTALLATION & OWNER'S MANUAL

*ALL IN ONE Type Air-source Heat Pump Water Heater*

Original instructions  
Thank you very much for purchasing our product,  
Before using your unit , please read this manual carefully and keep it for future reference.





## WARNING

This unit is required reliable earthing before usage, otherwise might cause death or injury

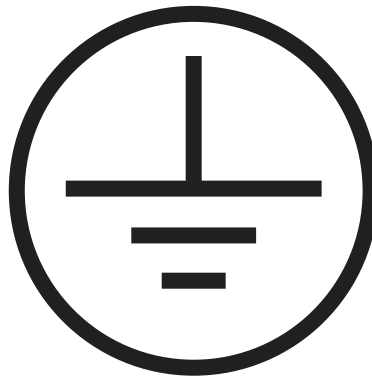

If you can't make sure that your house power supply is earthed well, please don't install the unit.

Please have a qualified person perform the reliable earthing connection and the installation of the unit.

Examples of a qualified person include: licensed plumbers, authorized electric company personnel, and authorized service personnel.

**Your safety is the most important thing we concerned!**

# PARTS NAMES

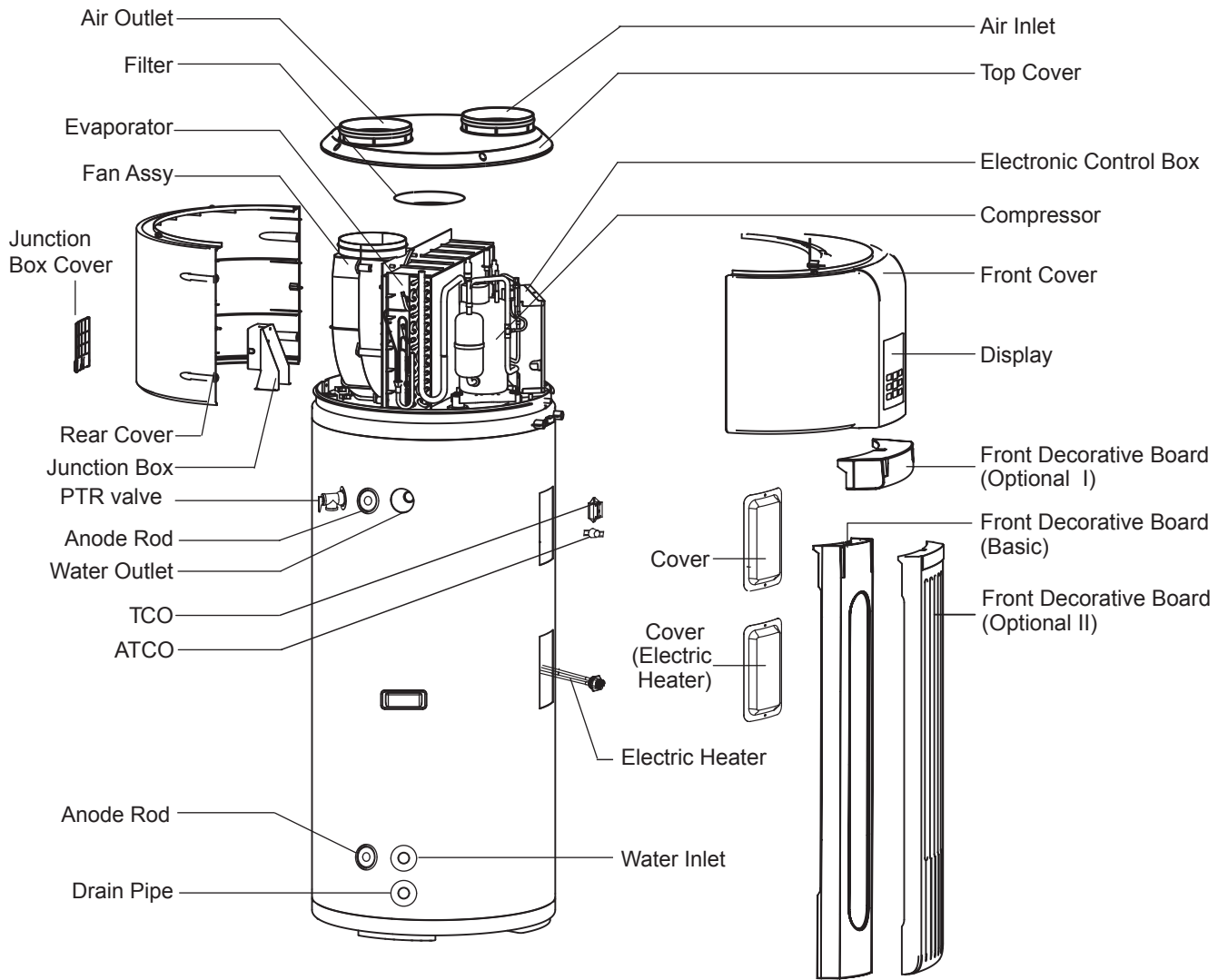

When ordering repair parts please always give the following information:

- 1) Model, serial and product number.
- 2) Parts name.



## NOTE

All the pictures in this manual are for explanation purpose only. They may be slightly different from the heat pump water heater you purchased (depend on model). Please refer to the real sample instead of the pictures of this manual.

CONTENTS	PAGE
BASIC OPERATION PRINCIPLE.....	1
SAFETY INFORMATION.....	1
BEFORE INSTALLATION.....	2
INSTALLATION.....	4
TRIAL-RUNNING.....	9
OPERATION .....	12
TROUBLE SHOOTING.....	15
MAINTENANCE.....	17
SPECIFICATIONS.....	18

## 0. BASIC OPERATION PRINCIPLE

As we know with our experience, the natural flow of heat, which moves from a higher to a lower temperature source. The heat pump can transfer heat from a lower temperature source to a higher temperature source with high efficiency.

The advantage of a heat pump water heater is that it can supply more heat energy, normally 3 times than input electricity power by extracting the heat from ambient atmosphere in a free charge way to Sanitary Hot Water, compare to the traditional water heater, such as electric water heater or gas burner water heater, their efficiency is normally less than 1, which means it will dramatically cut off the bill of family daily SHW by the application of heat pump water heater, following data will show more details.

Power consumption comparison under the same condition to heat 1 ton water from 15°C to 55°C

The equivalent heat load  $Q=CM(T_1-T_2)=1(kCal/kg^{\circ}C)$

$X1000(kg) \times (55-15)(^{\circ}C)=40000kCal=46.67kW^{\ast}h$

Table. 0-1

	HPWH	Gas Burner	E-heater
Energy Resource	Air,Electricity	Gas	Electricity
Transfer Factor	860kCal/kW*h	24000kCal/m <sup>3</sup>	860kCal/kW*h
Average Efficiency (W/W)	3.5	0.8	0.95
Energy Consumption	13.33kW*h	2.08m <sup>3</sup>	49.13 kW*h
Unit Cost	0.09 USD/kW*h	2.84 USD/m <sup>3</sup>	0.09 USD/kW*h
Running Cost USD	1.2	5.9	4.42

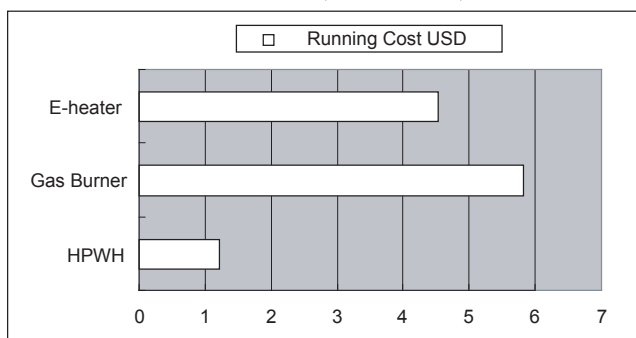

Fig.0-1



### NOTE

Above calculation is based on the ideal condition, the final cost bill will be different caused by the actual running conditions, such as running period, ambient temperature, etc.

## 1. SAFETY INFORMATION

Please read thoroughly all of the instructions before installing or operating the unit.

Following safety symbols are very important, always read and obey all safety symbols:

	<b>CAUTION</b>	You may be injured if you don't obey instructions.
	<b>WARNING</b>	You may be killed or seriously injured if you don't obey instructions.
	<b>DANGER</b>	You may be killed or seriously injured immediately if you don't obey instructions.



### WARNING

- The unit must be earthed effectively.
- A creepage breaker must be installed adjacent to the power supply.
- Do not remove, cover or deface any permanent instructions, labels, or the data labels from either the outside of the unit or inside of unit panels.
- Ask qualified person to perform the installation of this unit in accordance with local national regulations and this manual. Improper installation may result in water leakage, electric shock or fire.
- Ask qualified person for relocating, repairing and maintaining the unit instead of doing by yourself. Improper installation may result in water leakage, electric shock or fire.
- Electric connection work should obey the instructions of local power company, local electric utility and this manual.
- Never use the wire and fuse with wrong rated current, otherwise unit may break down and cause fire furthermore.
- Do not insert fingers, rods or other objects into the air inlet or outlet. When the fan is rotating at high speed, it will cause injury.
- Never use a flammable spray such as hair spray, lacquer paint near the unit. It may cause a fire.
- This appliance is not intended for use by persons (including children) with reduced physical, sensory or mental capabilities, or lack of experience and knowledge, unless they have been given supervision or instruction concerning use of the appliance by a person responsible for their safety. Children should be supervised to ensure that they do not play with the appliance.(FOR EN STANDARD)
- This appliance can be used by children aged from 8 years and above and persons with reduced physical, sensory or mental capabilities or lack of experience and knowledge if they have been given supervision or instruction concerning use of the appliance in a safe way and understand the hazards involved. Cleaning and user maintenance shall not be made by children without supervision. (FOR IEC STANDARD)

- If the supply cord is damaged, it must be replaced by the manufacturer or its service agent or a similarly qualified person.
- **DISPOSAL:** Do not dispose this product as unsorted municipal waste. Collection of such waste separately for special treatment is necessary.
- Do not dispose of electrical appliances as unsorted municipal waste, use separate collection facilities.
- Contact your local government for information regarding the collection systems available. If electrical appliances are disposed of in landfills or dumps, hazardous substances can leak into the groundwater and get into the food chain, damaging your health and well-being.



- Do not turn off the power supply. System will stop or restart heating automatically. A continuous power supply for water heating is necessary, except service and maintenance.
- If the unit has not been used for a long period of time (2 weeks or more), hydrogen gas will be produced in the water piping system.

Hydrogen gas is extremely flammable. To reduce the risk of injury under these conditions, it is recommended that open the hot water tap for several minutes at the kitchen sink before using any electrical appliance connected to the hot water system. When hydrogen is present, there will probably be an unusual sound such as air escaping through the pipe as the water begins to flow. There should be no smoking or open flame near the tap at the time it is open.

## 2. BEFORE INSTALLATION

### 2.1 Unpacking

#### 2.1.1 Accessories

Table. 2-1

Accessory Name	Qty.	Sharp	Purpose
Owner's & Installation Manual	1		Installation and use instruction This manual
One Way Valve	1		Prevent water from flowing backwards
Adaptor	1		Drain condensate water

#### 2.1.2 How to transport

- 1) In order to avoid scratch or deformation of the unit surface, apply guard boards to the contacting surface. No contact of fingers and other things with the vanes. Don't incline the unit more than 15° in moving, and keep it vertical when installing.

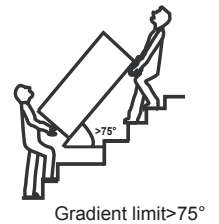

- 2) This unit is heavy, it need to be carried by two or more persons, otherwise might cause injury and damage.

### 2.2 Location requirements

- 1) Enough space for installation and maintenance shall be preserved.
- 2) The air inlet and outlet should be free from obstacles and strong wind.
- 3) The base surface should be flat, surface should be inclined no more than 2° and able to bear the weight of the unit and suitable for installing the unit without increasing noise or vibration.
- 4) The operation noise and air flow expelled shall not affect neighbors.
- 5) No flammable gas is leaked nearby.
- 6) It is convenient for piping and wiring.
- 7) If it is installed in indoor space, it might cause indoor temperature decreased and noise. Please take preventive measures for this.
- 8) If the unit has to be installed on a metal part of building, make sure the well electric insulation which should meet the relevant local electric standard.



### CAUTION

- The earthing pole of socket must be grounded well, make sure that power supply socket and plug are dry enough and connected tightly.
- How to check the power supply socket and plug are qualified? Turn on power supply and keep the unit running for a half hour, then turn off power supply and plug out, check whether the socket and plug is hot or not.
- Before cleaning, be sure to stop the operation and turn the breaker off or pull out the power plug. Otherwise, an electric shock and injury may be caused.

- Water temperature over 50°C can cause severe burns instantly or death from scalds. Children, disabled and elderly are at highest risk of being scalded. Feel water before bathing or showering. Water temperature limiting valves are recommended.



- Do not operate the unit with a wet hand. An electric shock may be caused.
- The installation height of power supply should be over 1.8m, if there is any water spattered, separate the power supply from water.
- A one-way valve must be installed on the water inlet side, which is available from accessories, see manual "accessories" part.
- It's normal if some water drops from the hole of PTR valve during operation. But, if there is a great amount of water, call your service agent for instructions.
- After a long term use, check the unit base and fittings. If damaged, the unit may sink and result in injury.
- Arrange the drain pipe to ensure smooth draining. Improper drainage work may cause wetting of the building, furniture etc.
- Do not touch the inner parts of the controller. Do not remove the front panel. Some parts inside are dangerous to touch, otherwise a machine malfunction may be caused.



## CAUTION

- The ambient air temperature must also be considered when installing this unit, in heat pump mode the ambient air temperature must be above  $-7^{\circ}\text{C}$  and below  $43^{\circ}\text{C}$ . If the ambient air temperature falls outside these upper and lower limits, the electrical elements will be activated to meet the hot water demand and the heat pump does not operate.
- The unit should be located in an area not subject to freezing temperatures. The unit located in unconditioned spaces (i.e., garages, basements, etc.) may require the water piping, condensate piping, and drain piping to be insulated to shelter against freezing.



## CAUTION

Installing the unit in any of the following places may lead to malfunction (If it is inevitable, consult the supplier).

- The site contains mineral oils such as lubricant of cutting machines.
- Seaside where the air contains much salt.
- Hot spring area where corrosive gases exist, e.g., sulfide gas.
- Factories where the power voltage fluctuates seriously.
- Inside a car or cabin.
- The place with direct sunlight and other heat supplies. If there's no way to avoid these, please install a covering.
- Place like kitchen where oil permeates.
- Place where strong electromagnetic waves exist.
- Place where flammable gases or materials exist.
- Place where acid or alkali gases evaporate.
- Other special environments.



## WARNING

- The unit must be securely fixed, otherwise, noise and shaking may be resulted.
- Make sure that there's no obstacle around the unit.
- In the place where there is strong wind like seashore, fix the unit in the location protected from the wind.

### 2.3 Maintenance space requirements (unit: mm)

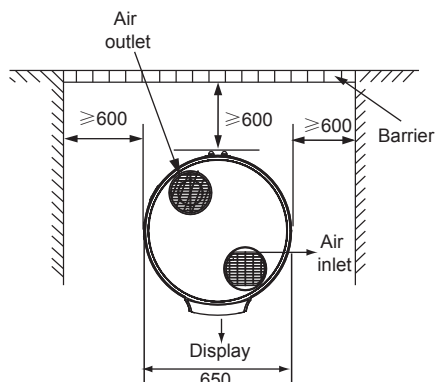

Fig. 2-1

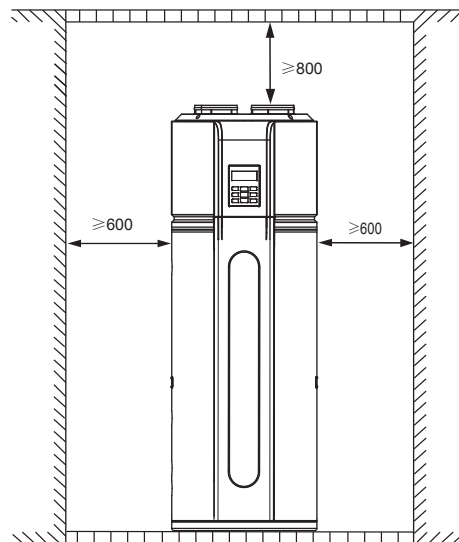

Fig. 2-2

### 2.4 If installed in inclosed space

The water heater must be located in a space  $>15\text{m}^3$ , and must have unrestricted air flow. As an example, a room that has an 2.5 tall ceiling and is 3 meter long by 2 meter wide would contain  $15\text{m}^3$ .

### 2.5 Unit outline dimension (unit: mm)

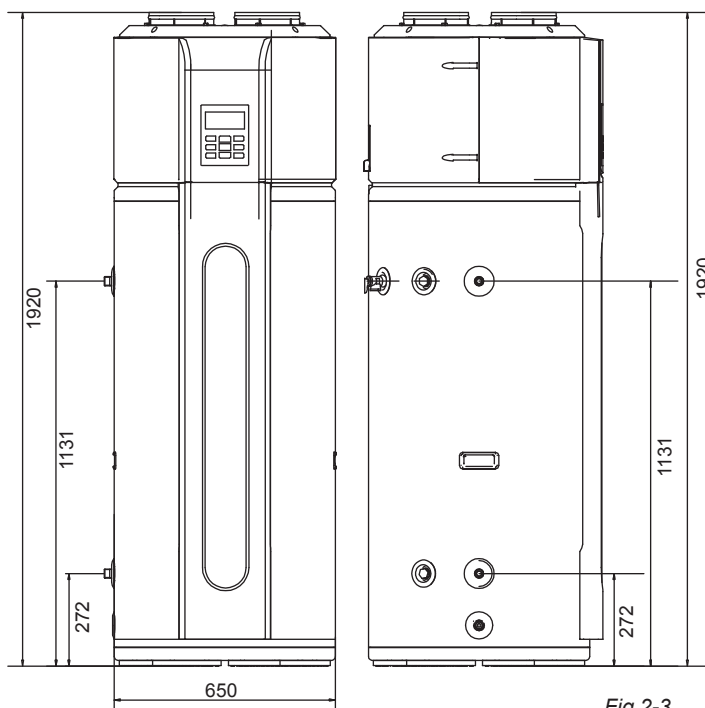

Fig. 2-3

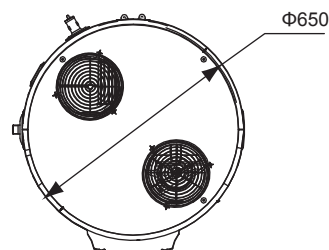

Fig. 2-4

### 3. INSTALLATION

The circulating air for every unit should be more than 350m<sup>3</sup>/h. Make sure there is enough installation space. Outline dimensional drawing (see Fig.2-3, Fig.2-4).

#### 3.1 Water System Piping

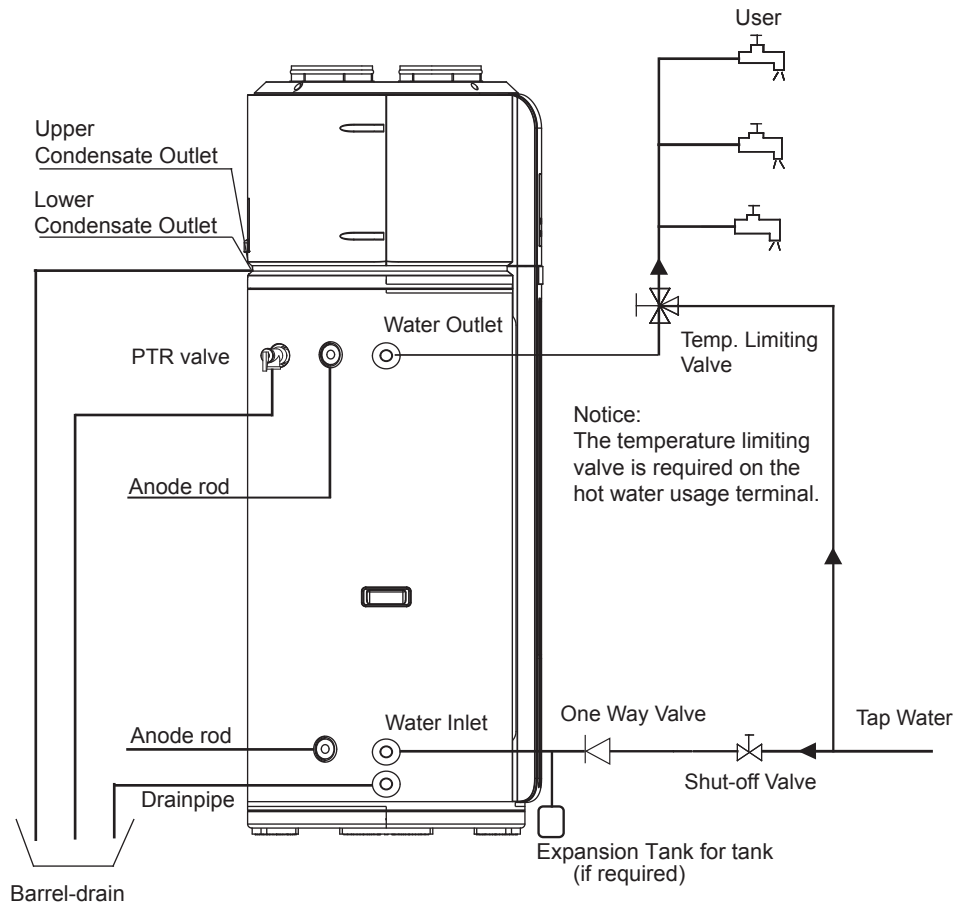

Fig.3-1

Water inlet or outlet pipes: The spec of the water inlet or outlet thread is RC3/4" (external thread). Pipes must be heat-insulated well.

- 1) Installation of the pipe for PTR valve: The spec of the valve connecting thread is RC3/4" (internal thread). After installation, it must be confirmed that the drainpipe outlet is exposed in the air.



#### CAUTION

- Piping water system as the above figure. In case of installing it at a place where outside temperature below freezing point, insulation must be provided for all hydraulic components.
- The handle of PTR valve should be pulled out once per half a year to make sure that there is no jam of the valve. Please beware of burn, beware of the hot water from the valve. The drainage pipe should be well insulated in order to prevent water inside pipe from freezing in cold weather.

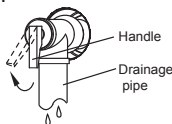

#### WARNING



EXPLOSION

- Do not dismantle the PTR valve.
  - Do not block off the drainage pipe.
- It will cause explosion and injury, if do not comply with the above instruction.

- 2) Installation of the One Way Valve: The spec of the One Way Valve thread in accessories is RC3/4". It is used to prevent water from flowing backwards.
- 3) After water system piping work, turn on the cold water inlet valve and hot water outlet valve and start effusing the tank. When water flow smoothly out from water outlet pipe (tap water outlet), the tank is full, turn off all valves and check pipeline to make sure there is not any leakage.
- 4) If the inlet water pressure is less than 0.15MPa, a pump should be installed at the water inlet. For guarantee the safety usage of tank at the condition of water supply pressure higher than 0.65MPa, a reducing valve should be installed at the water inlet pipe.
- 5) Condensate may be leaked from unit if drainage pipe is blocked or unit operates in high humidity environment, a drainage pan is recommended as shown as following figure:

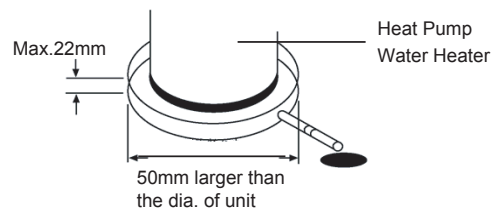

Fig.3-2



### 3.2 Air duct connection

1) Air inlet and outlet with ducts. ( $A+B+C+D \leq 10m$ )

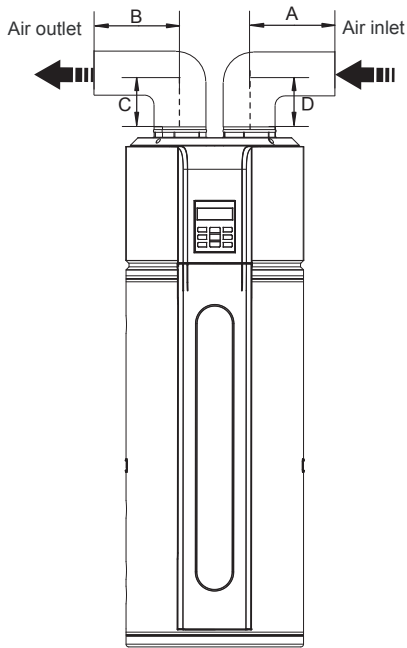

Fig.3-3

3) Air outlet connects to duct, air inlet without duct. ( $B+C \leq 10m$ )

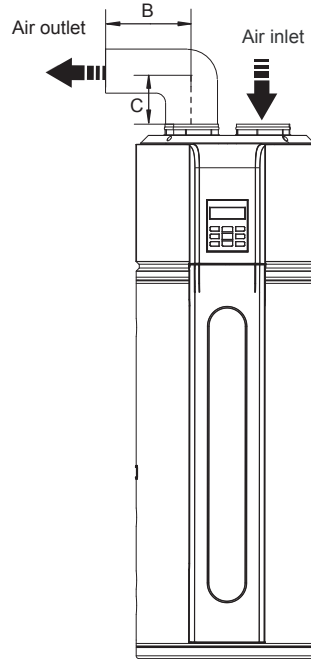

Fig.3-5

It is recommended to install unit by this way in the winter where there is other heat source in the room.

2) Air outlet without duct, air inlet connects to duct. ( $A+D \leq 10m$ )

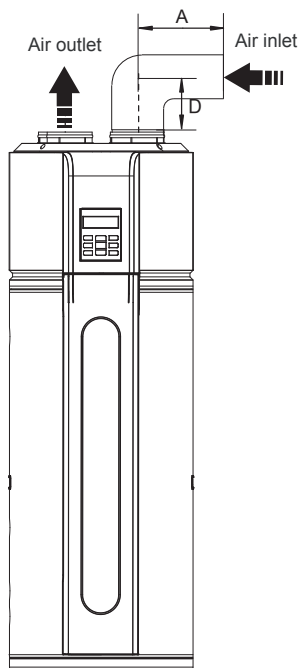

Fig.3-4

It is recommended to install unit by this way in summer that could charge fresh air into room.

4) Duct Description

Table. 3-1

Duct	Round duct	Rectangle duct	Other shaped duct
Dimension (mm)	Φ 190	190X190	Refer to above data
Straight-line pressure drop (Pa/m)	≤2	≤2	
Straight-line length (m)	≤10	≤10	
Bent pressure drop(Pa)	≤2	≤2	
Bent's qty.	≤3	≤3	



## NOTE

- The resistance of duct will decrease air-flow-rate, which will lead to capacity of unit decreased.
- For the case of unit with duct, the duct total length should be no more than 10m or the maximum static pressure should be within 25Pa, and the quantity of bending should be no more than 3.
- For unit with duct, when unit operating, condensate will be generated around outside of duct. Please pay attention to the drainage work, we suggest to wrap the thermal insulated layer around outside of the duct.
- It is recommended to install the unit in the indoor space, it is not allowed to install the unit at the rainy space.

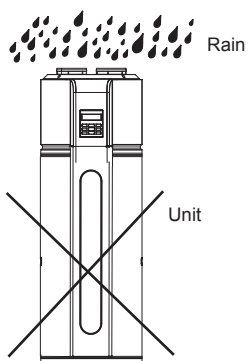

Fig.3-6

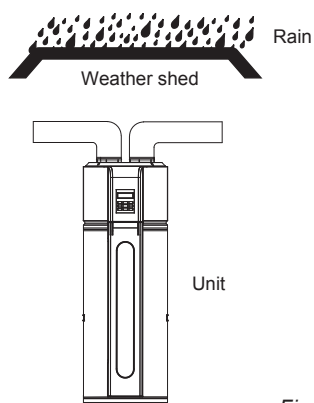

Fig.3-7



## WARNING

- In case of rain entering to internal components of the unit, the component might be damaged or causing physical danger. (Fig.3-6)
- In terms of the unit connects with duct reaching to outdoor, a reliable water-resistant measure must be conducted on the duct, to prevent water from dropping into internal of the unit. (Fig.3-7)

- 5) Filter installing at the unit inlet. In terms of the unit with duct, filter in there must be put on the position of duct inlet. (Fig.3-8/3-9)

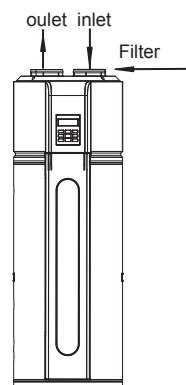

Fig.3-8

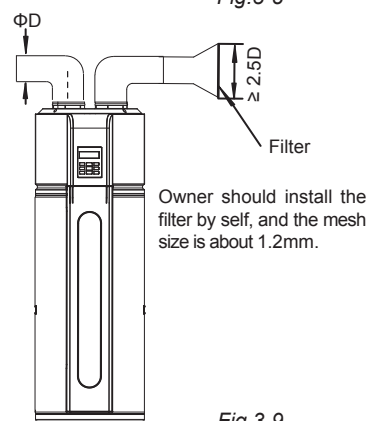

Fig.3-9

- 6) To smoothly drain condensate from unit, please install the unit at a horizontal floor. Otherwise, please ensure the drain vent is at the lowest level. Recommending the inclination angle of unit to the ground should be no more than 2°.

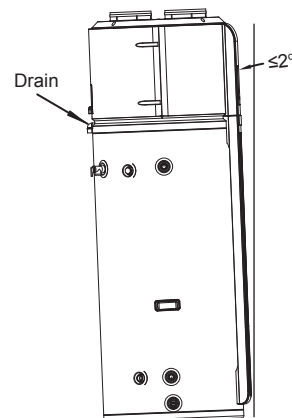
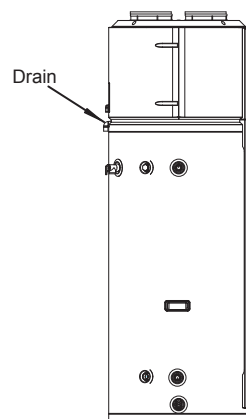

Fig.3-10

### 3.3 Electric Connection

#### 3.3.2 Specifications of Power Supply

Table. 3-2



### CAUTION

- The power supply should be an independent circuit with rated voltage.
- Power supply circuit should be earthed effectively. The wiring must be performed by professional technicians in accordance with national wiring regulations and this circuit diagram.
- An all-pole disconnection device which has at least 3mm separation distance in all pole and a residual current device (RCD) with the rating of above 10mA shall be incorporated in the fixed wiring according to the national rule.
- Set the electric leakage protector according to the relevant electric technical standards of the state.
- The power cord and the signal cord shall be laid out neatly and properly without mutual interference or contacting the connection pipe or valve.
- After wire connection, check it again and make sure the correctness before power on.

Model Name	RSJ-35/300RDN3-F1
Power Supply	220-240V~50Hz
Mlin. Diameter of Power Supply Cord (mm <sup>2</sup> )	4
Earth Cord (mm <sup>2</sup> )	4
Manual Switch(A) Capacity/Fuse (A)	40/30
Creepage Breaker	30 mA ≤0.1sec

- Please choose the power cord according to above table, and it should comply with local electric standard.
- The power cord model, recommended power cord mode is H05RN-F.



### WARNING

The unit must be installed with an Creepage Breaker near the power supply and must be effectively earthed.

#### 3.3.1 Electric Wiring Illustration

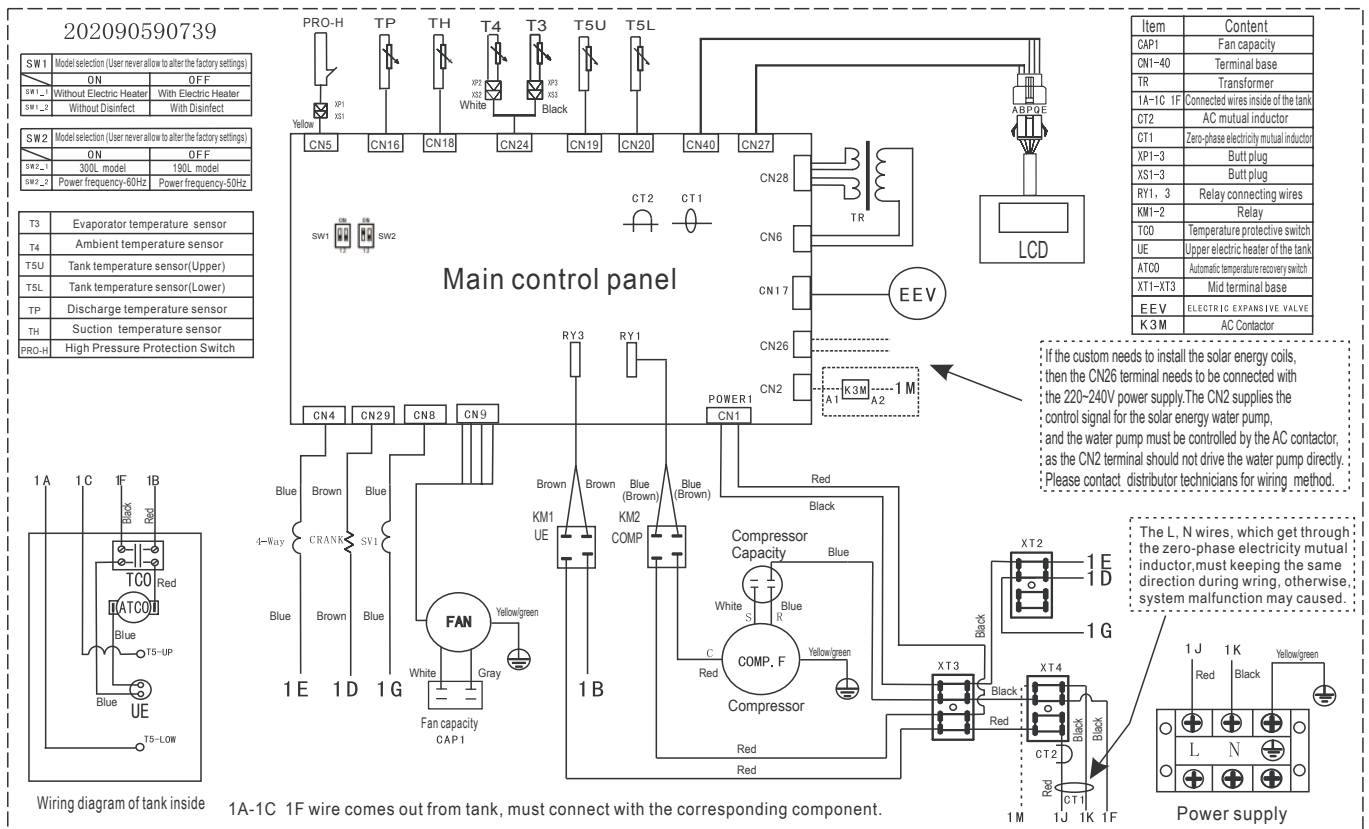

- T3: Evaporator Temp. Sensor
- T4: Ambient Temp. Sensor
- T5U: Tank Temp. Sensor (upper)
- T5L: Tank Temp. Sensor (lower)
- TP: Discharge Temp. Sensor
- TH: Suction Temp. Sensor

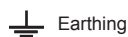

Fig.3-11

### 3.3.3 PCB I/O Ports description

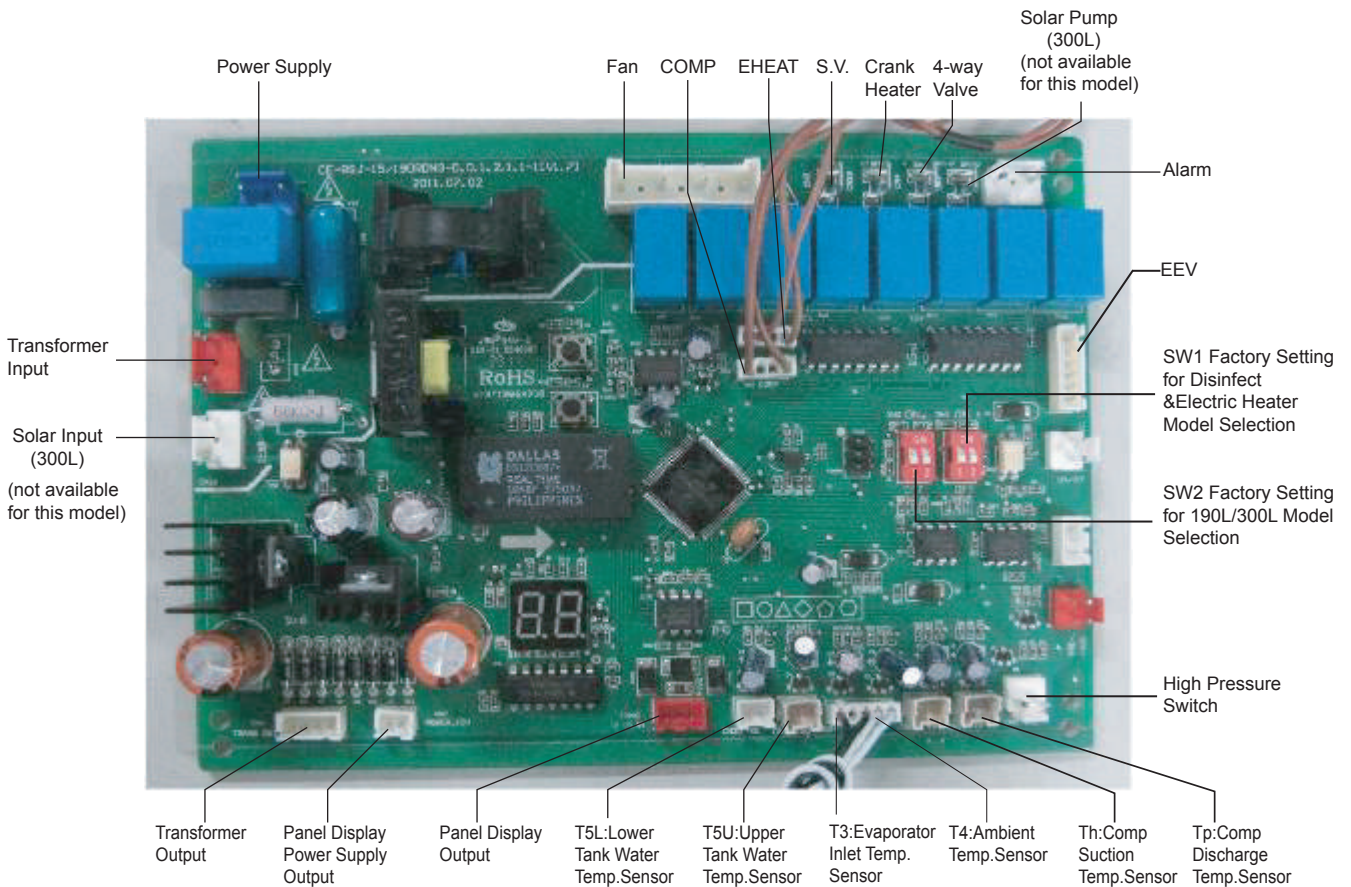

Fig.3-12

### 3.3.4 Switch setting

- PCB has 2 bits of switches.

Table. 3-4

SW1	Model selection (User never allow to alter the factory settings)	
	ON	OFF
SW1 - 1	Without Electric Heater	With Electric Heater
SW1 - 2	Without Disinfect	With Disinfect

Table. 3-5

SW2	Model selection (User never allow to alter the factory settings)	
	ON	OFF
SW2 - 1	300L model	190L model
SW2 - 2	Power frequency_60Hz	Power frequency_50Hz

### 3.3.5 Electric leakage protector

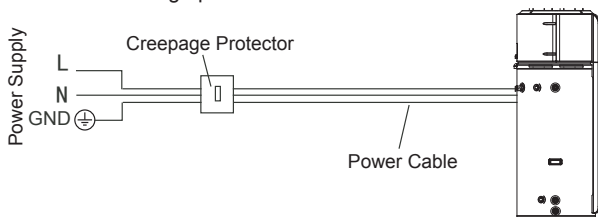

Fig.3-13

## 3.4 Installation checklist

### 3.4.1 Location

- The flooring beneath the water heater must be able to support the weight of the unit when filled with water (more than 445kg).
- Located indoors (such as a basement or garage) and in a vertical position. Sheltered from freezing temperatures.
- Provisions made to shelter the area from water damage. Metal drain pan installed and piped to an adequate drain.
- Sufficient space to service the water heater.
- Sufficient air for the heat pump to function, the water heater must be located in a space >15m<sup>3</sup>, and must have unrestricted air flow.



### NOTE

For optimal efficiency and service ability, the following clearances should be maintained: 800mm on the air inlet side, 800mm on the air outlet side, 600mm in the back, and 600mm in the front.

- The unit cannot be placed into any type of closet or small enclosure.
- The site location must be free from any corrosive elements in the atmosphere such as sulfur, fluorine, and chlorine. These elements are found in aerosol sprays, detergents, bleaches, cleaning solvents, air fresheners, paint, and varnish removers, refrigerants, and many other commercial and household products. In addition excessive dust and lint may affect the operation of the unit and require more frequent cleaning.
- The ambient air temperature must be above -7°C and below 43°C. If the ambient air temperature falls outside these upper and lower limits the electrical elements will be activated to meet the hot water demand.

### 3.4.2 Water System Piping

- PTR valve(Temperature and pressure relief valve) properly installed with a discharge pipe run to an adequate drain and sheltered from freezing.
- All piping properly installed and free of leaks.
- Unit completely filled with water.
- Water temperature limit valve or mixer tap(recommended) installed per manufacturer's instructions.

### 3.4.3 Condensate Drain Line Installation

- Must be located with access to an adequate drain or condensate pump.
- Condensate drain lines installed and piped to an adequate drain or condensate pump.

### 3.4.4 Electrical Connections

- The water heater requires 230 VAC for proper operation.
- Wiring size and connections comply with all local applicable codes and the requirements of this manual.
- Water heater and electrical supply are properly grounded.
- Proper overload fuse or circuit breaker protection installed.

### 3.4.5 Post Installation Review

- Understand how to use the User Interface Module to set the various parameters and functions.
- Understand the importance of routine inspection/maintenance of the condensate drain pan and lines. This is to help prevent any possible drain line blockage resulting in the condensate drain pan overflowing.
- **IMPORTANT:** Water coming from the plastic shroud is an indicator that both condensation drain lines may be blocked. Immediate action is required.
- To maintain optimal operation check, remove and clean the air filter.

## 4. TRIAL-RUNNING

### 4.1 Water affusion before operation

Before using this unit, please follow the steps below.

Water Affusion: If the unit is used for the first time or used again after emptying the tank, please make sure that the tank is full of water before turning on the power.

Method: see Fig.4-1

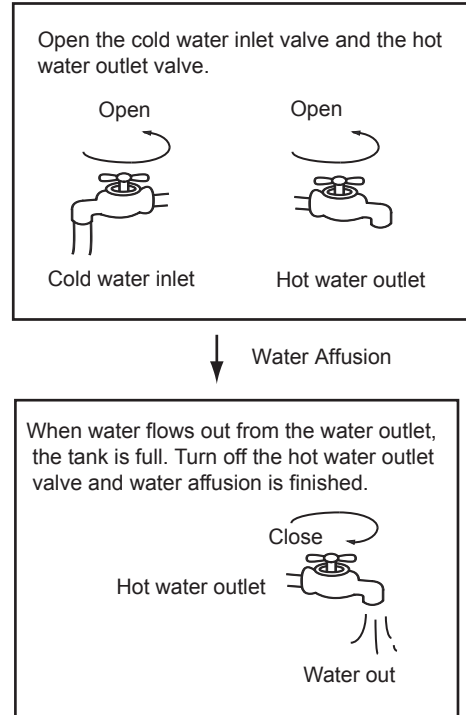

Fig.4-1



### CAUTION

- Operation without water in water tank may result in the damage of auxiliary E-heater. Due to such damage, manufacturer will not be liable for any damages caused by this issue.



- After powered on, the display lights up. Users can operate the unit through the buttons under the display.
- Emptying: If the unit needs cleaning, moving etc, the tank should be emptied. Method: See Fig.4-2:

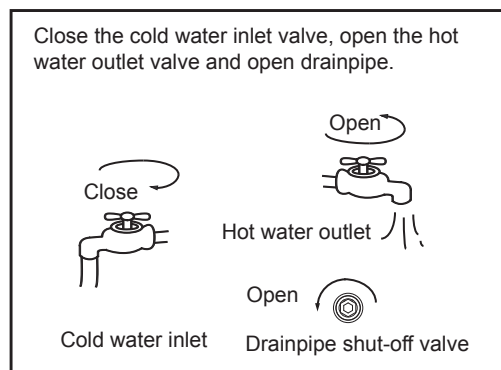

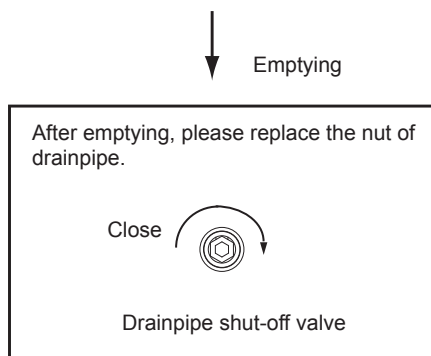

Fig.4-2

- Running Temperature Range  
Setting water temperature target range: 38~65°C.  
E-heater running ambient temperature range: -20~43°C.  
Heat pump running ambient temperature range: -7~43°C.  
Water temperature limits:

Table. 4-1

Model	RSJ-35/300RDN3-F1					
Ambient Temp.(T4)	T4<-7	-7≤T4<-2	-2≤T4<2	2≤T4<7	7≤T4<43	T4≥43
Max.Temp.(Heat pump)	--	42	47	55	65	--
Max. Temp.(E-heater)	65	65	65	65	65	65

## 4.2 Trial- running

### 4.2.1 Checking list before commissioning.

- 1) Checking list before trial-running.
- 2) Correct installation of the system.
- 3) Correct connection of water/air piping and wiring.
- 4) Condensate draining smoothly well insulation work for all hydraulic part.
- 5) Correct power supply.
- 6) No air in the water pipeline and all valves opened.
- 7) Effective electric leakage protector installation.
- 8) Sufficient inlet water pressure (between 0.15MPa and 0.65MPa).

### 4.2.2 About Running

#### 1) System Structure Figure

Unit has two kinds of heat sources: heat pump(compressor) and electric heater.  
Unit will automatically select heat sources to heat water to the target temperature.

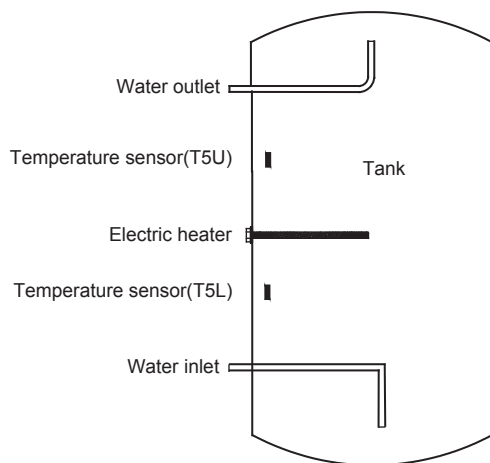

Fig.4-3

#### 2) Water Temperature Display

The temperature shown on the display depends on the upper sensor. So it is normal that the display temperature has reached to target temperature but compressor still running, because the lower water temperature does not get to target temperature.

- 3) Heat source will be automatically selected by unit. But manually E-Heater operation is available.

#### 4) Heat Source Shift

- The default heating source is heat pump.  
If ambient is range out of heat pump, heat pump will stop running, the unit will shift automatically to activate E-heater and show the icon LA( ) on the display, then if the ambient temperature goes into the running range of heat pump again, it will stop E-heater and shift automatically to heat pump again, and the icon LA( ) will be extinguished.
- If the target setting water temperature is higher than Max. temp(Heat pump), the unit will activate heat pump firstly to the Max. temperature, then stop heat pump, activate E-heater to continually heat water to the target temperature.
- If manually activate the E-heater running when heat pump running, E-heater and heat pump will work together until the water temperature gets to target temperature. So if want to heat quickly, please manually activate E-heater.



### NOTE

- E-heater will be activated once for the current heating progress, if want to apply E-heater again, please push **E-HEATER** again.
- If only use E-heater, about only 150 liters water will be heated, so must set higher target water temperature if ambient temperature is out of heat pump running range.

#### • Defrosting During Water-heating

In heat pump running period, if the evaporator frosted in lower ambient temperature, the system will defrost automatically to keep effective performance(about 3~10min). At defrosting time, the fan motor will stop, but compressor will still run.

#### • COP

There is different COP in different ambient temperature. Normally lower ambient temperature result longer heat-up time because of lower effective performance.

- When ambient temp below 7°C, heat pump and E-heater will take different portions of heating capacity, generally the lower of ambient temperature, the lower portion of heat pump will be taken as well as the higher portion of E-heater will account for. More detail please refer to Table.4-1 and Table.4-2.



- About TCO and ATCO  
The power of E-heater will be automatically shut-off or turn on by TCO and ATCO.

If the water temperature is higher than 78°C, the ATCO will automatically shut off the power of compressor and E-heater, and reconnect it if the temperature falls down below 68°C.

If the water temperature is higher than 85°C, the TCO will automatically shut off the power of compressor and E-heater. After that it needs to be reset manually by pressing the red button on the TCO.

- Restart After a Long Term Stop  
When the unit is restarted after a long term stop(trail running included), it is normal that outlet water is unclean. Keep the tap on and the water will be clean soon.

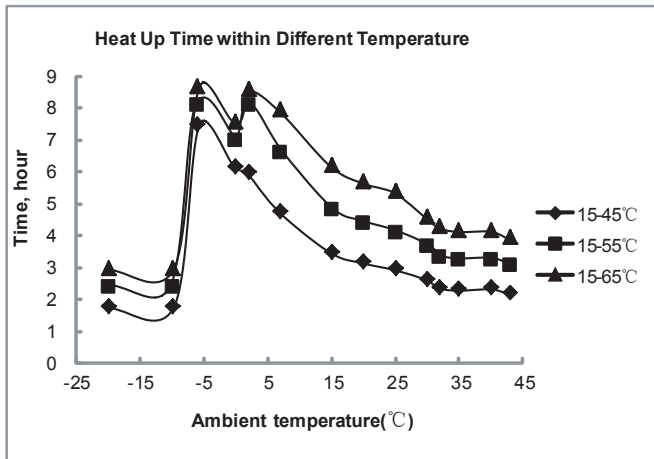

Fig. 4-4

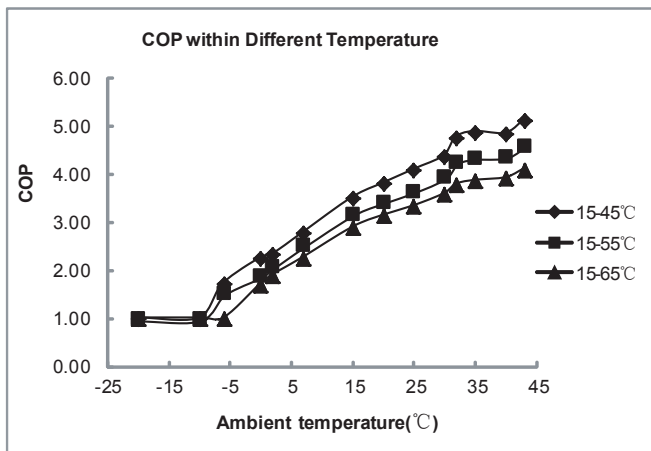

Fig. 4-5

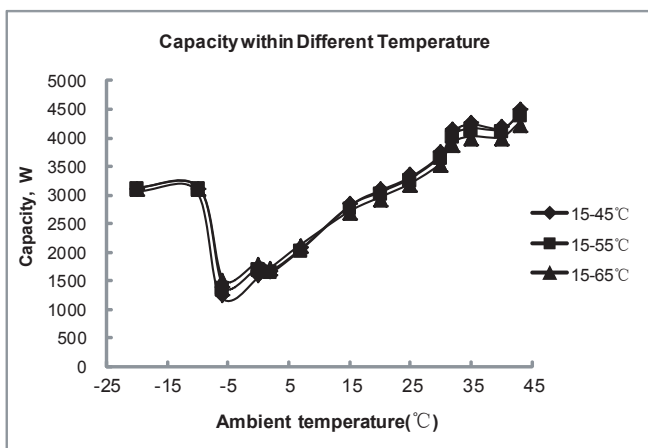

Fig. 4-6



**NOTE**

While the ambient temperature below than -7°C, heat pump efficiency will decrease dramatically, the unit will automatically shift to E-heater running.

4.2.3 Basic function

- 1) Weekly disinfect function  
Under disinfection unit immediately start to heat water up to 65°C to kill the potential legionella bacteria inside water of tank. icon will light on the display screen during disinfection. Unit will quit disinfection if water temperature is higher than 65°C and extinguish icon.

- 2) Vacation function  
After pressing **VACATION** button, unit will automatically heat water to 15°C for the purpose of energy saving during vacation days.

- 3) How is the unit running  
If unit is OFF->press ->unit will be waken->press to set target water temperature(38-65°C)->press ->unit will automatically select heat source and start to heat water to target temperature.

4.2.4 Query function

For the convenience of maintenance and debug, query function is available by press 2 buttons together: **E-HEATER** + **DISINFECT**, then system running parameters will be shown one by one with following sequence by each pushing of or button.

Table. 4-3

No.	Hour low bit	Min. high bit	Min. Low bit	Temp./Dasys	Explanation
1	t	5	U	Temp.	T5U
2	t	5	L	Temp.	T5L
3		t	3	Temp.	T3
4		t	4	Temp.	T4
5		t	p	Temp.	TP
6		t	h	Temp.	TH
7		l	E	Current	Compressor
8	1				Last error code
9	2				Previous 1st error or protection code
10	3				Previous 2nd error or protection code
11					Software number

# 5. OPERATION

## 5.1 Control Panel Explanation

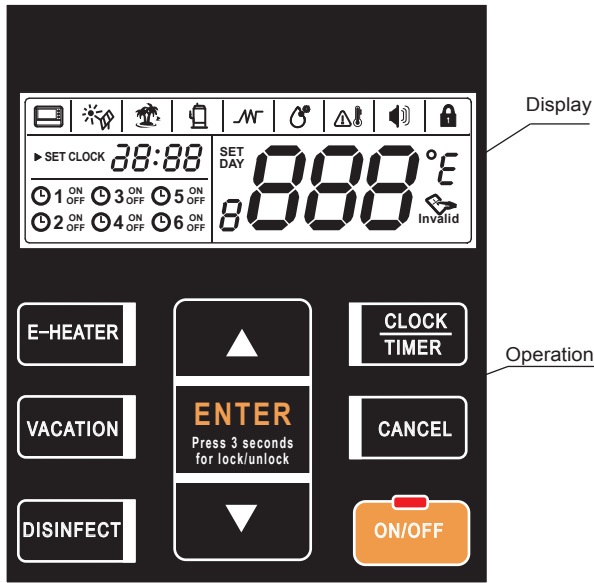

Fig.5-1

## 5.2 Display Explanation

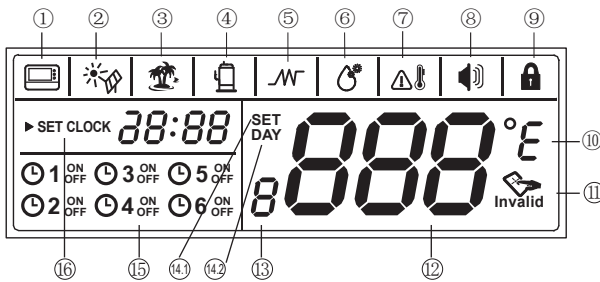

Fig.5-2

Table. 5-1

No	Icon	Description
①		<b>Wire controller:</b> If connected a wire controller,  will be lightened, otherwise  be extinguished.
②		<b>Outside solar heat source:</b> If an outside solar heat source has been connected to the unit,  will flash with 0.5 Hz frequency, otherwise  will be extinguished.
③		<b>Vacation:</b> will be lightened if the unit is under vacation, otherwise  will be extinguished; will flash with 2Hz frequency when setting vacation.
④		<b>Compressor:</b> will be lightened when compressor is running, otherwise  will be extinguished.

No	Icon	Description
⑤		<b>E-heater:</b> will be lightened if E-heater is activated, otherwise  will be extinguished. If E-heater is automatically activated by unit,  will be lightened; If E-heater is manually activated,  will flash with 0.5 Hz frequency. When setting E-heater manually ON/OFF,  will flash with 2 Hz frequency.
⑥		<b>Disinfect:</b> will be lightened when the unit is under disinfecting, otherwise  will be extinguished. will be lightened if disinfect function is automatically activated by unit; will flash with 0.5 Hz frequency, if disinfect function is manually activated; will flash with 2Hz frequency when setting disinfect function or setting disinfect timer.
⑦		<b>High temp. Alarm</b> If setting water temp. is higher than 50℃,  will be lightened, otherwise  will be extinguished.
⑧		<b>Alarm:</b> When unit is under protection/error,  will flash with 5Hz frequency as well as buzzer will sound 3 times every 1 minute until protection/error eliminated or press <b>CANCEL</b> for 1 second.
⑨		<b>Lock:</b> If button is locked,  will be lightened, otherwise  will be extinguished.
⑩		<b>Temperature unit</b> If setting temperature unit as celsius, °C will be lightened,  will show celsius degree; If setting temperature unit as Fahrenheit, °F will be lightened,  will show Fahrenheit degree. Long press button <b>E-HEATER</b> for 10s to shift it.
⑪		<b>Invalid</b> If button is under lock mode, press any button except unlock button,  will be lightened.
⑫		<b>888:</b> will be lightened if screen is unlocked. It shows water temperature on normal; It shows remaining vacation days on vacation; It shows setting temperature on setting; It shows unit setting/running parameters, error/protection code on querying.
⑬		<b>Reserved</b> 
⑭		<b>Setting</b> <b>SET</b> will be lightened when setting water temperature or setting days for vacation.
⑭		<b>Date setting</b> <b>DAY</b> will be lightened when setting days for vacation; <b>DAY</b> will be lightened when on vacation.



No	Icon	Description
15		<p><b>Timer</b></p> <p>There are six timers can be set. If anyone of them has been set, 1, 2, 3, 4, 5, 6 will lighten the corresponding one when screen is unlocked; If there is none of timers has been set, it will keep extinguished. If timer is being set, 1, 2, 3, 4, 5, 6 will flash the corresponding one with 2Hz frequency as well lighten the timer which has been set.</p>
16		<p><b>Clock and clock setting</b></p> <p>28:88 shows the clock. Whenever there is any setting for clock, SET CLOCK will be lightened.</p>

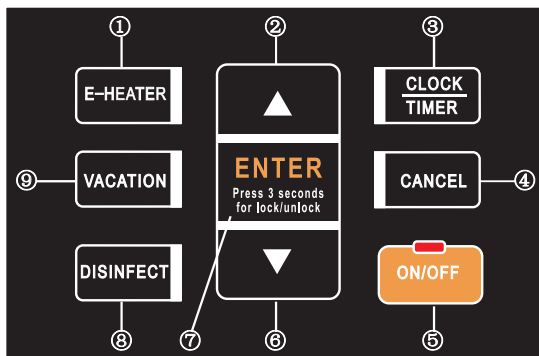

Fig. 5-3

Any pressing of button is effective only under button and display unlocked state.

Table. 5-2

No.	Icon	Description
1		<p><b>Manually turn E-heater ON</b></p> <p>If E-heater is OFF, follow these steps below to manually turn it on.</p> <p> will flash.</p> <p> Confirm manually turning E-heater on, then E-heater is activated to heat up water to the target temperature. After that, if need manually turn E-heater on again, please repeat these steps.</p> <p>If E-heater is already ON, Press  will lead to show invalid icon  on the display.</p> <p>Long pressing the button  for 10s then can shift to set the temperature display unit from "F" to "C" or from "C" to "F". The default is "C"(when it's shifted to display "F", it still will display "C" while querying).</p>
2		<p><b>INCREASE</b></p> <p>If screen is unlocked, corresponding value will increase by pushing .</p> <ul style="list-style-type: none"> <li>When setting temperature, press  more than 1s, Temperature value will be increased continuously;</li> <li>When Setting clock/timer, press  more than 1s, Clock/timer value will be increased continuously;</li> <li>When setting vacation days, press  more than 1s, day value will be increased continuously;</li> </ul> <p>On querying, check items will page up by pressing .</p>







No	Icon	Description
3.1		<p><b>Set Clock</b></p> <p>Press button  for 3 sec to enter clock setting. Then icon  will be lightened and the hour value of clock will flash slowly.</p> <p> Set the hour value of clock.</p> <p> Confirm the hour setting. Then the minute value of clock will flash slowly.</p> <p> Set the minute value of clock.</p> <p> Confirm the minute setting and quit clock setting.</p>
3.2		<p><b>Set Timer</b></p> <p> Enter timer setting.</p> <p> Select timer (1 ~ 6) which needs to be set. The timer icon will flash slowly if it is selected.</p> <p> Confirm the selected setting timer. Then  will be lightened. Then the hour value of timer will flash slowly.</p> <p> Set the hour value of timer.</p> <p> Confirm the hour value of timer. Then the minute value of timer will flash slowly.</p> <p> Set the minute value of timer.</p> <p> Confirm the minute value of timer. Then ON or OFF icon following the setting timer will flash slowly.</p> <p> Set the action(ON or OFF) of the timer.</p> <p> Confirm the action(ON or OFF) of the timer.</p> <p> The display screen will automatically display different value at 888 by different action. It will display the last set temperature and icon , if the action is ON, and will display  if the action is OFF.</p> <p> Set the water temperature of the setting timer.</p> <p> Confirm and complete the timer. Then repeat this process to set another timer.</p>

No	Icon	Description
		<p><b>Cancel Timer</b></p> <p>Enter timer checking.</p> <p>Select timer( 1~6) which needs to be cancel. The timer icon will flash slowly if it is selected.</p> <p>Confirm to cancel the timer. Then repeat selecting timer and cancelling. If the timer has not been set, when press button CANCEL the display will show Invalid. After complete cancelling timer, press button CANCEL for 3sec to quit timer cancelling.</p>
12	CLOCK TIMER	<p><b>Check Timer</b></p> <p>Enter timer checking.</p> <p>Select time (1~6) which needs to be checked. The timer icon will flash slowly if it is selected, and the timer action(ON or OFF) and set clock will be shown. If the action is ON, target temperature will be shown. And if the action is OFF, icon -- will be shown.</p> <p>Press button CANCEL for 3sec or no button pressing for 30sec to quit timer checking.</p> <p>If there is confliction between Timer and Manually ON:  1) The moment of Manually ON has priority;  2) The moment of Timer OFF has priority;</p>
4	CANCEL	<p><b>CANCEL CANCEL</b></p> <p>To cancel setting, quit setting, clear alarm, ect.  To clear alarm buzzer, need to press it for 1sec.</p>
5	ON/OFF	<p><b>ON/OFF</b> ON/OFF button and LED indicator</p> <p>If unit is standby, press ON/OFF, then unit will be OFF.  If unit is ON, press ON/OFF, then unit will be OFF.  If unit is OFF, press ON/OFF, then unit will be ON.  LED indicator will be lightened if unit is ON or standby and extinguished if unit is OFF.</p>
6	Decrease/Down Arrow	<p><b>Decrease/Down Arrow</b></p> <p>If screen is unlocked, corresponding value will decrease by pushing Decrease/Down Arrow.</p> <ul style="list-style-type: none"> <li>When setting temperature, press Decrease/Down Arrow more than 1s, temperature value will be decreased continuously;</li> <li>When Setting clock/timer, press Decrease/Down Arrow more than 1s, Clock/timer value will be decreased continuously;</li> <li>When setting vacation days, press Decrease/Down Arrow more than 1s, day value will be decreased continuously;</li> </ul> <p>On querying, check items will page down by pressing Decrease/Down Arrow.</p>

No	Icon	Description
7	ENTER	<p><b>ENTER CONFIRM/UNLOCK</b></p> <p>If screen and buttons are unlocked, press it to upload setting parameters after setting any parameter:</p> <ul style="list-style-type: none"> <li>If press it within 10sec, setting parameters will be uploaded to unit;</li> <li>If press it beyond 10sec, please resetting all parameters.</li> </ul> <p>If screen and buttons are locked, press it for 3s to unlock them.</p>
8	DISINFECT	<p><b>DISINFECT DISINFECT</b></p> <p>Manually turn on disinfect function</p> <p>Icon will flash.</p> <p>Confirm manually activate disinfection function, then the unit will heat up water to 65°C at least for disinfection.</p> <p><b>Disinfect Clock Setting</b></p> <p>Press button DISINFECT for 3sec to enter disinfect clock setting. Then icon will flash, and icon SET CLOCK will be lightened and the hour value of clock will flash slowly.</p> <p>Set the hour value of clock.</p> <p>Confirm the hour setting. Then the minute value of clock will flash slowly.</p> <p>Set the minute value of clock.</p> <p>Confirm the disinfect clock setting and quit out.</p> <p>Unit will automatically start disinfect function at the above-set clock every 7 days.  If user don't set disinfect clock, unit will automatically start disinfect function at 23:00 every 7 days.  If unit is OFF or under disinfecting, press DISINFECT will lead to show Invalid on the display.</p>
9	VACATION	<p><b>VACATION VACATION</b></p> <p>Vacation Setting</p> <p>Enter vacation setting. Icon will flash. Icon SET DAY will be lightened. 888 will show the last setting vacation days.</p> <p>Set vacation days. The days range is 1~99 days(default as 14 days).</p> <p>Confirm vacation setting and quit out. The unit will immediately go into vacation.</p>

No	Icon	Description
9	VACATION	In vacation period, the setting target water temperature is 15°C as default and <b>888</b> will show the remanent vacation days. On the last day of vacation, unit will automatically start disinfect function, and automatically reset the target temperature to the last one before vacation. If unit has already been in vacation or OFF, press <b>VACATION</b> will lead to show invalid icon  on the display.

### 5.3 Combination button

No.	Icon	Description
Clear error code	 + 	Press the two buttons at the same time to clear all stored error & protect codes, and the buzzer will buzz one time.
Query	 + 	Press the two buttons at the same time for 1sec to go into querying. On querying user can check unit setting & running parameters by pressing   circularly. Press button  for 1s or no button operation for 30s, then quit querying.

### 5.4 Auto-restart

If electricity power failed, unit can memorize all setting parameters, unit will be back to the previous setting when power recover.

### 5.5 Button Auto Lock

When there is no operation of button for 1 minute, button will be locked except Unlock button . Press  for 3s, unlock buttons.

### 5.6 Screen Auto Lock

If there is no operation of button for 30s, screen will be locked(extinguished) except for error code and alarm icon.  
Press any button will unlock the screen(lighten).

## 6. TROUBLE SHOOTING

### 6.1 Non-error tips

- Q: Why compressor can't start immediately after setting?  
A: Unit will wait for 3 minutes to balance the pressure of system before starting compressor again, it's a self protection logic of unit.
- Q: Why sometimes the temperature shown on the display panel decreased while unit is running?  
A: When the upper tank temperature is much higher than the bottom part, upper part hot water will be mixed by the bottom cold water which is continually flow from inlet tap water so that will decrease the upper part temperature.

Q:Why sometimes the temperature shown on the display decreased but unit still keep closed?

A: To avoid unit ON/OFF frequently, unit will activate heat source only when bottom tank temperature is lower than setting temperature or max. temperature for at least 5 °C.

Q:Why sometimes the temperature shown on the display will decreased dramatically?

A: Because tank is pressure-bearable type, if there is massive hot demand, hot water will quickly tapped out from upper part of tank as well as cold water will quickly tapped into bottom part of bank if the cold water surface emerge the upper temperature sensor, temperature shown on the display will decreased dramatically.

Q: Why sometimes the temperature shown on the display is decreased a lot, but there is still a mount of hot water can be tapped?

A: Because the upper water sensor is located on the upper 1/4 tank, when display temperature starts falling down quickly, it means there is at least 1/4 tank of hot water available.

Q: Why sometimes unit shows "LA" on display ?

A: The heat pump available running ambient range is -7-43°C, if ambient temperature is out of range, system will show above-mentioned signal to let user notice it.

Q: Why something there is nothing shown on the display?

A: To maintain display screen lifespan within along term, when there is no button operation for 30 sec, it will extinguish the display except the LED indicator.



Q: Why sometimes the buttons are unavailable?

A: If there is no operation on panel for 1 min, unit will lock the panel, shows , to unlock the panel, please press the "ENTER" button for 3 seconds.



Q: Why sometimes there is some water flowed from drainage pipe of PTR valve?

A: Because the tank is pressure-bearable one, when water is heated inside the tank, water will expand, so the pressure inside of tank will increase, if pressure goes up more than 1.0MPa, PTR valve will activate to relief the pressure and hot water drop will be discharged correspondingly. If water drop is continually discharged from PTR valve drainage pipe, it is abnormal, please contact qualified stuff to repair.

### 6.2 Something about self-protection of unit

- 1) When the self-protection happens, the system will be stopped and start self-check, and restart when the protection resolved.
- 2) When the self-protection happens, the buzzer will buzz in every other minute, the  will flash and error code will be shown at water temperature indicator. Press  button for 1sec to stop buzz, but the  and error code does not disappear until protection resolved.
- 3) In the following circumstance, self-protection may happen:  
Air inlet or outlet is blocked;  
The evaporator is covered with too much dust;  
Incorrect power supply(exceeding the range of 220-240V).

### 6.3 When error happened

- 1) If some normal errors happen, unit will automatically shift to E-heater for emergent SHW supply, please contact qualified staff to repair.
- 2) If some sever errors happen, unit will not start, please contact qualified staff to repair.
- 3) If some errors happen, the buzzer will buzz 3 times every other minute and the  will flash fast. Press  for 1 sec to stop the buzzer but the alarm icon will keep glittering.

## 6.4 Error phenomenon shooting

Table. 6-1

Error phenomenon	Possible reason	solution
Cold water tapped out and display screen extinguished	Bad connection between power supply plug and socket; Setting water temperature too low; Temp.sensor broken; PCB of indicator broken.	Plug in; Setting water temp. higher; Contact service center.
No hot water tapped out	Public water supply ceased; Cold water inlet pressure too low (<0.15 MPa); Cold water inlet valve closed.	Waiting for public water supply recover; Waiting for inlet water pressure increase; Open water inlet valve.
Water leakage	Hydraulic pipeline joints are not sealed well.	Check and reseal all joints.

## 6.5 Error code shooting table

Table. 6-2

Display	Malfunction Description	Corrective action
E0	Error of sensor T5U(upper water temperature sensor)	Maybe the connection between sensor and PCB has released or sensor has been broken. Contact a qualified person to service the unit.
E1	Error of sensor T5L(lower water temperature sensor)	Maybe the connection between sensor and PCB has released or sensor has been broken. Contact a qualified person to service the unit.
E2	Tank and Wired Controller communication error	Maybe the connection between controller and PCB has released or PCB has been broken.
E4	Evaporator temperature sensor T3 error	Maybe the connection between sensor and PCB has released or sensor has been broken. Contact a qualified person to service the unit.
E5	Ambient temperature sensor T4 error	Maybe the connection between sensor and PCB has released or sensor has been broken. Contact a qualified person to service the unit.
E6	Compressor discharge temperature sensor TP error	Maybe the connection between sensor and PCB has released or sensor has been broken. Contact a qualified person to service the unit.
E8	Electric leakage error If PCB current_induction_circuit check the current difference between L,N >14mA, system consider it as "electric leakage error"	Maybe some wires have been broken or bad wire connection. Contact a qualified person to service the unit.
E9	Compressor suction temperature sensor TH error	Maybe the connection between sensor and PCB has released or sensor has been broken. Contact a qualified person to service the unit.
EE	E-heater open-circuit error( IEH(Current difference E-heater on & E-heater off )<1A)	Maybe the E-heater has been broken or bad wire connection after repair.
EF	Clock chip error	Maybe the chip has been broken, but unit can work well without clock-menmory, so it is needed to reset clock when power put on again. If necessary, contact a qualified person to service the unit.
Ed	E-EEPROM chip error	Contact a qualified person to service the unit.
P1	System high pressure protection ≥ 3.0MPa active : ≤ 2.4Mpa inactive	Maybe because of system blocked, air or water or more refrigerant in system(after repair), water temperature sensor malfunction, ect. Contact a qualified person to service the unit.

P2	High discharge temperature protection TP>110 ℃, Protection active TP<90 ℃, Protection inactive	Maybe because of system blocked, air or water or less refrigerant(leakage) in system( after repair), water temperature sensor malfunction, ect. Contact a qualified person to service the unit.
P3	Compressor abnormally stopped protection The discharge temperature is not so higher than evaporator temperature after compressor running a term.	Maybe because of compressor broken or bad connection between PCB and compressor. Contact a qualified person to service the unit.
P4	Compressor overloaded protection (10 secs after compressor startup, current checking starts , 1)only compressor running, if it is >10A , the compressor will be stopped and protected.) 2)Compressor+E-heater running, if it is >IEH+10,the compressor will be stopped and protected.)	Maybe because of compressor broken, system blocked, air or water or more refrigerant in system(after repair), water temperature sensor malfunction, ect. Contact a qualified person to service the unit.
LA	When the ambient temp T4 is out of Heat Pump running range (-7~ 43 ℃ ) Heat Pump will stop, unit will show LA on the position of clock on display until T4 back to (-7~ 43 ℃ ). Only valid for the unit without E-heater. Unit with E-heater will never show "LA".	It is normal, and no necessary to repair.



#### NOTE

- The diagnostic codes listed above are the most common. If a diagnostic code not listed above is displayed, contact residential technical assistance referencing the number on the front of this manual.
- If any of P1/P2/P3/P4 continuously appear 3 times within single heating cycle, system will consider it as "Heat Pump system error". The third failure code and will be shown on the display, then heat pump will stop running, and the unit will shift automatically to active E-heater as the backup heat source, but the third failure code and will be shown until power is reset. Contact a qualified person to service the unit.

- Open the drainage valve, and drain out the water, until there are no water flow out.
- Get off the anode rod.
- Replace with a new one, and make sure effective sealed.
- Open cold water inlet tap until water flows out from outlet tap, then turn of water outlet tap.
- Power on then restart the unit.

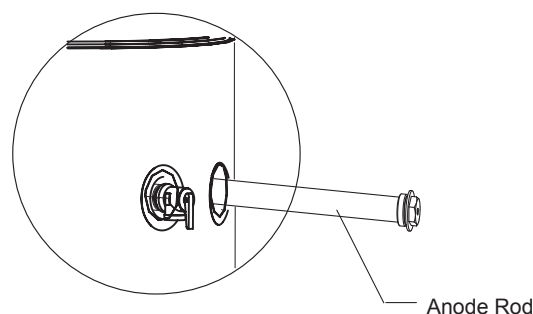

Fig. 7-1

## 7. MAINTENANCE

### 7.1 Maintenance

- Check the connection between power supply plug and socket and ground wiring regularly;
- In some cold area (below 0℃), if the system will be stopped for a long time, all the water should be released in case of freezing of inner tank and damage of E-heater.
- It is recommended to clean the inner tank and E-heater every half year to keep an efficient performance.
- Check the anode rod every half year and change it, if it has been used out. For more details, please contact the supplier or the after-sale service.
- It is recommended to set a lower temperature to decrease the heat release, prevent scale and save energy if the outlet water volume is sufficient.
- Clean the air filter every month in case of any inefficiency on the heating performance.  
In terms of the filter set in air inlet directly (namely, air inlet without connect with duct), the method of dismantle the filter is: anti-clockwise unscrew the air inlet ring, take out the filter and clean it completely, finally, remount it to the unit.
- Before shutting the system off for a long time, please:  
Shut off the power supply;  
Release all the water in water tank and the pipeline and close all the valves;  
Check the inner components regularly.
- How to change the anode rod
  - Turn off the power, and turn off the water inlet valve.
  - Open hot water tap, and decrease the pressure of the inner container.

### 7.2 Recommended regular maintenance table

Table. 7-1

Checking Item	Checking content	Checking frequency	Action
1	air filter (inlet/outlet)	every month	Clean the filter
2	anode rod	every half year	Replace it if it has been used out
3	inner tank	every half year	Clean the tank
4	E-heater	every half year	Clean E-heater
5	PTR valve	every year	Operate the hander of PTR valve to ensure that waterways are clear.
	If water doesn't flow freely when operating the hander, replace PTR valve with a new one.		

## 8. SPECIFICATIONS

Table. 8-1

Model		RSJ-35/300RDN3-F1
Water-heating cap.		3000W
Rated power/AMPS		4600W/20A
Power supply		220-240V~ 50Hz
Operation control		Auto/Manual startup, error alarm, timer,etc
Protection		High-pressure Protector, Over-load Protector, Temp Controller&Protector, etc
E-heater power		3150W
Refrigerant		R134a(1200g)
Water pipeline system	Outlet water temp.	Default 55°C, (38-65°C adjustable )
	Water side exchanger	Safety condenser,copper tube wrapped around outside of storage tank
	Inlet pipe Dia.	DN20
	Outlet pipe Dia.	DN20
	Drain pipe Dia.	DN20
	PTR valve Dia.	DN20
	Max. pressure	1.0MPa
Exchanger air side	Material	Hydrophilic aluminum fin, inner groove copper tube
	Motor power	80W
	Air circulation way	outlet/inlet vertically, duct connection available
Dimension		Φ650×1920mm
Water tank cap.		280L
Net weight		145.5kg
Fusible link type		T30A 250VAC
<p>The test conditions:            Ambient temperature 15/12°C(DB/WB),            Water temperature from 15°C up to 45°C.</p>		

## 8.1 Important information for the used refrigerant

This product has the fluorinated gas, it is forbidden to release to air.  
Refrigerant type: R134A; Volume of GWP: 1430;  
GWP=Global Warming Potential

Model	Factory charge	
	Refrigerant/kg	tonnes CO <sub>2</sub> equivalent
RSJ-35/300RDN3-F1	1.20	1.72

### Attention:

#### Frequency of Refrigerant Leak Checks

- 1) For equipment that contains fluorinated greenhouse gases in quantities of 5 tonnes of CO<sub>2</sub> equivalent or more, but of less than 50 tonnes of CO<sub>2</sub> equipment, at least every 12 months, or where a leakage detection system is installed, at least every 24 months.
- 2) For equipment that contains fluorinated greenhouse gases in quantities of 50 tonnes of CO<sub>2</sub> equivalent or more, but of less than 500 tonnes of CO<sub>2</sub> equipment, at least every six months, or where a leakage detection system is installed, at least every 12 months.
- 3) For equipment that contains fluorinated greenhouse gases in quantities of 500 tonnes of CO<sub>2</sub> equivalent or more, at least every three months, or where a leakage detection system is installed, at least every six months.
- 4) This air-conditioning unit is a hermetically sealed equipment that contains fluorinated greenhouse gases.
- 5) Only certificated person is allowed to do installation, operation and maintenance.